

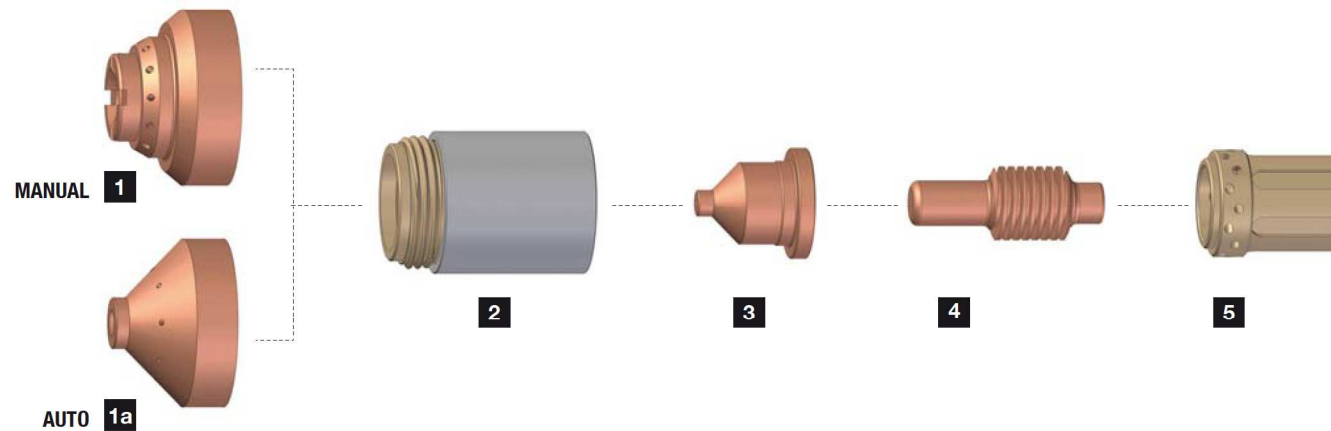

Soluzione in blister - Blister's solution - Solution en blisters - Solución en blister

Powermax 600 [®]	(PAC 123T/M)
Powermax 800 [®]	(PAC 121TS/M) (PAC 125T/M)
Powermax 900 [®]	(PAC 125T/M)





CODE		A	600	800	900	REF	Pcs X 	 X 
------	--	---	-----	-----	-----	-----	--	---

1 SCHERMO MAN - SHIELD MAN - PATIN MAN - ESCUDO MAN

CV0108P		40	•			T120828H	1	2
CV0106P		40 55		•	•	T120601H	1	2

1a SCHERMO AUT - SHIELD AUT - PATIN AUT - ESCUDO AUT

CV0107P		40	•			T120827H	1	2
CV0183P		40 55		•	•	T120602H	1	2

2 UGELLO PORTA SCHERMO - RETAINING GAP - DUSE PROTECTION - TOBERA DE RETENCIÓN

PC0087P		55	•	•	•	T120600H	1	2
---------	---	----	---	---	---	----------	---	---

3 CAPPÀ - NOZZLE - TUYÈRE - BOQUILLA



PD0133P10		40	•			T120826H	5	2
PD0083P10		40		•		T120438H	5	2
PD0083P11		50		•		T120282H	5	2
PD0145P10		55			•	T120577H	5	2

CODE		A	600	800	900	REF	Pcs X 	 X 
------	--	---	-----	-----	-----	-----	--	---

4 ELETTRODO - ELECTRODE - ELECTRODE - ELECTRODO

PR0133P		40 55	•	•	•	T120573H	5	2
---------	---	----------	---	---	---	----------	---	---

5 DIFFUSORE VESPEL - SWIRL RING VESPEL - DIFFUSEUR VESPEL - DIFFUSOR VESPEL

PE0299P		40 55	•		•	T120576H	1	2
PE0300P		40 50		•		T020361H	1	2